



WC and urinal flush systems. By SCHELL.

SCHELL.

The specialist for public, semi-public and commercial sanitary rooms.



Plant 1
Production with administration building and training centre



EDITION ECO design control panel
for SCHELL concealed COMPACT II WC flush valve

Ultimate hygiene, attractive design, high level of user frequency or minimal investment – just a few examples of how the requirements for urinal and WC flush systems in public, semi-public and commercial sanitary rooms can vary. SCHELL prepares you for everything. Ultimately, our name has been synonymous with intelligent fitting technology »Made in Germany« for over 80 years.

What you can expect of us: an unrivalled broad product range of intelligent solutions for WCs and urinals. From attractive front-facing and controls panels as well as state-of-the-art fitting technology to mounting modules. Regardless of whether you are looking for new build projects or refurbishments. Regardless of whether you want inexpensive manual flush actuation or a hygienic contact-free variant. Regardless of whether the fitting is vandal-proof or particularly water-efficient.

SCHELL is your single-source partner. And not just that: As one of the first manufacturers, SCHELL has products that are allowed to be classified according to the new European WELL classification mark.

Why not find out what is actually in our products. And if you have any queries regarding our urinal and WC flush system, simply give us a call. We are more than happy to help.

Telephone +49 (0) 27 61 8 92-0
www.schell.eu

List of contents

SCHELL inside.	Page 4
<hr/>	
WC flush systems	Page 10
<i>Concealed solutions Overview</i>	Page 12
Manual control	Page 14
Electro-mechanical control	Page 16
Cistern systems with control panels	Page 18
Cistern systems with infrared control	Page 19
<hr/>	
<i>Wall-mounted solutions Overview</i>	Page 20
Manual control	Page 22
<hr/>	
Urinal flush systems	Page 24
<i>Concealed solutions Overview</i>	Page 26
Infrared control	Page 28
Manual control	Page 29
LC siphon sensor control	Page 31
<hr/>	
<i>Wall-mounted solutions Overview</i>	Page 34
Manual control	Page 36
Infrared control	Page 38
<hr/>	
Mounting modules	Page 40
<hr/>	
References	Page 42



SCHELL inside.

WC flush systems
Concealed

WC flush systems
Wall mounted



Urinal flush systems
Concealed

Urinal flush systems
Wall mounted

Mounting modules

SCHELL *inside.*

SCHELL responds with robust, hygienic and resource-efficient solutions wherever they are needed, such as in public, semi-public and commercial sanitary rooms that experience high numbers of users. Our solutions can be found all across the world e.g. in

- Schools
- Nurseries
- Hotels
- Gastronomy
- Hospitals
- Residential nursing homes
- Industry
- Administrative buildings
- Airports
- Railway stations
- Motorway service stations
- Leisure facilities
- Sports facilities
- Swimming pools



WC flush systems

SCHELL satisfies even the highest of demands with its comprehensive range for water-saving and hygienic WC systems. From flush valve for the wall-mounted installation and concealed installation solutions to concealed cisterns. These can be controlled mechanically or electronically as you choose. All in all, ideal prerequisites for both simple and speedy retrofitting in renovation projects and for new-build installations. A perfect match: our mounting modules.



Wash basin fittings

Water-saving, hygienic, robust, long-lasting and good to look at too – this is what makes wash-basin and wall-mounted draw-off taps by SCHELL a cut above the rest. Available in different technical designs.

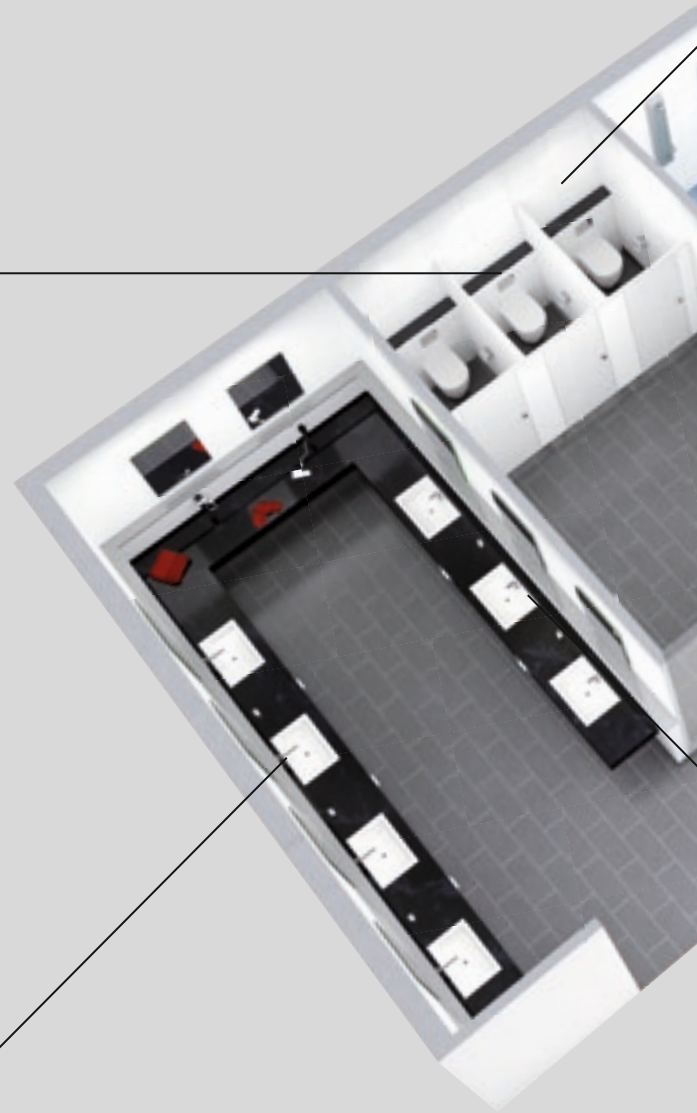

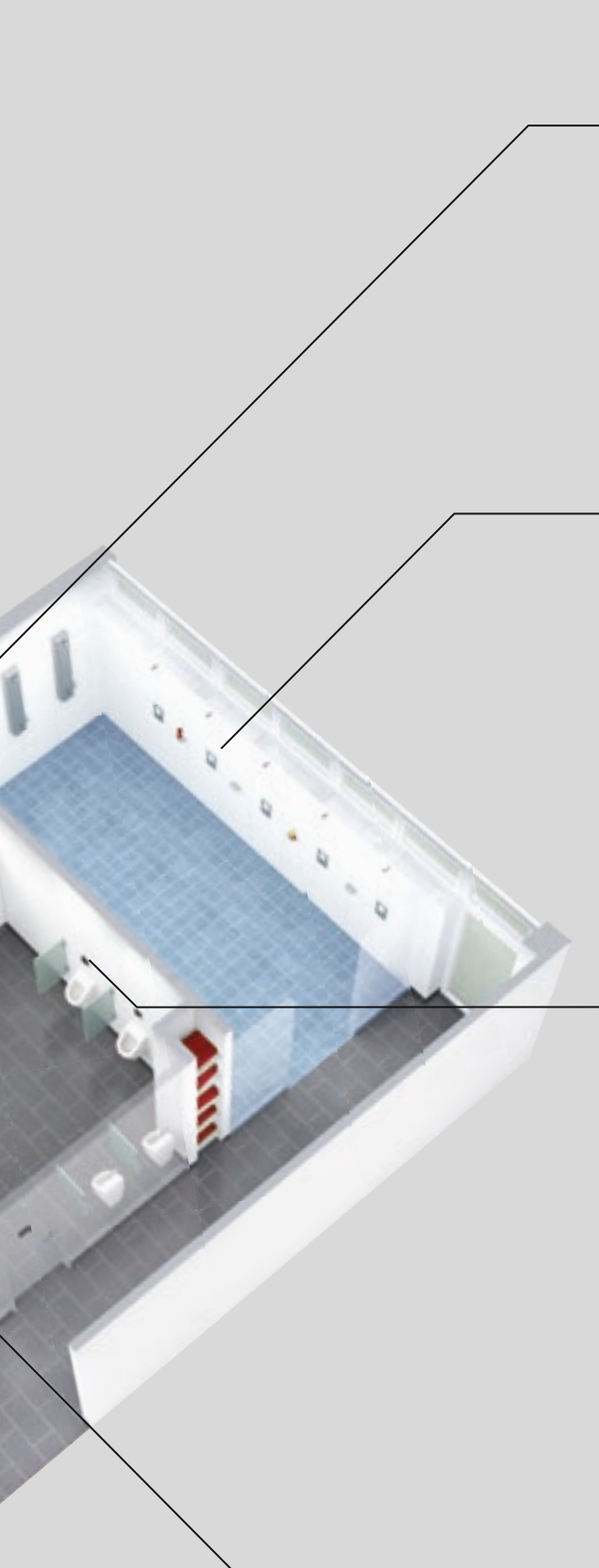

Mounting modules

SCHELL offers a complete range of mounting modules. What these typify: Models for dry and wet construction, compliance with DIN 4109 (noise protection in building construction) and a considerable number of innovative detailed solutions.

Shower fittings

Showers in public, semi-public and commercial sanitary rooms are in constant use. Irrespective of being in a new or renovated building: High-quality materials and a well-thought out design help our shower fittings achieve a long-lasting, water-efficient and disruption-free service life under these demanding conditions.

Urinal flush systems

These are in demand as concealed or wall-mounted installations: water-saving and hygienic urinal flush systems by SCHELL. Available as mechanical or electronic versions, they are suited for new builds or particularly for the quick and easy retrofitting in refurbishment projects. Urinal flush systems by SCHELL: combined with our mounting modules, these make the perfect all-round solution.

Angle valves

You can place high expectations on Europe's market leader for angle valves: water-saving functions, exceptional quality, attractive design and an extensive programme for all applications. Tailored to requirements, available with integrated backflow preventer or filter, almost every model classified in noise class I.



SCHELL inside.



WC flush systems
Concealed



WC flush systems
Wall mounted



Urinal flush systems
Concealed

Urinal flush systems
Wall mounted

Mounting modules

SCHELL is synonymous with sustainable solutions

And this is now official too.

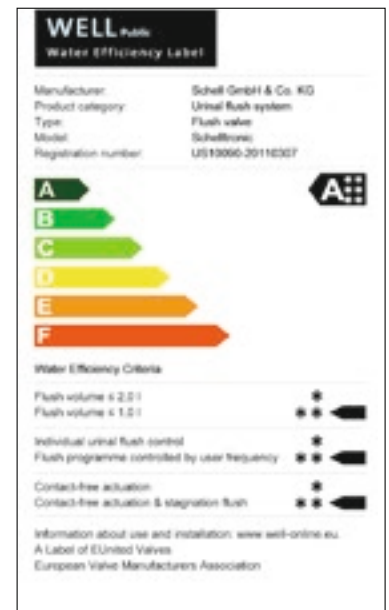

WELL, the new efficiency label of the European valve industry

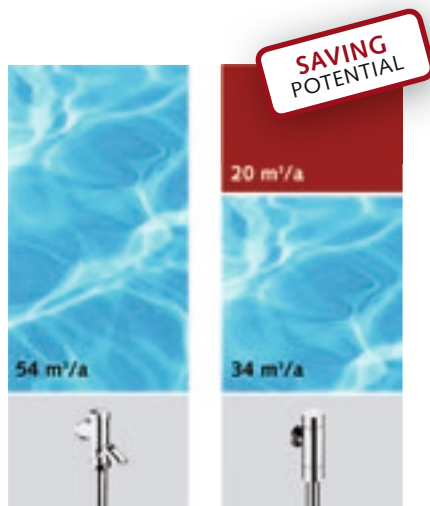

Conventional wall-mounted flush valve

SCHELL WC flush valves with economy button.

With an average price of EUR 5.16/m³ (cold clean water + waste water), this equates to a saving of EUR 103/year.

With its intelligent valve technologies, SCHELL has been proving for many years how to reduce water consumption in urinal and WC flush systems. For example via WC economy buttons, LC control in the hybrid programme or urinal »stadium programmes« that ensure the flush volumes are automatically used in the event of high-level usage. At SCHELL, we attach great importance to economy. And this is now official too. In order to provide planners and developers with a neutral orientation aid, the European valve industry (EUnited Valves) has now developed a new, informative and most importantly standardised product classification label that indicate the saving potential of a fitting in a bold

and striking manner. The basis for the qualification of each fitting, is compliance with applicable European norms and standards. This is tested and approved by an accredited, independent test institute (EN ISO/ICE 17025) as part of the type examination test. This ensures that only materials are used that are not hazardous in terms of hygiene and whose functional safety has been proven in an endurance test. Compliance with drinking water hygiene has the utmost priority. With the first WELL-classified fittings, SCHELL is documenting its very high aspirations on quality – and proves that minimal water consumption for fittings is not at odds with compliance with drinking water hygiene directives.

SCHELL is a member of the initiative



More information can be found at: www.blue-responsibility.com



SCHELL achieves highest international water-saving assessments



SCHELL is a member of EUnited Valves, the association of European valve manufacturers

SCHELL – a clean affair.
Even in terms of hygiene.



LINEAR ECO dual flush WC system



AMBITION E infrared-controlled urinal flush valve

Hygiene in sanitary rooms is a major challenge – especially when these are highly trafficked, such as in railway stations, restaurants and office buildings. SCHELL assumed this responsibility many years ago. Today, we are one of the pioneers of intelligent technologies for the toughest hygiene challenges.

The contact-free actuation of the flush via infrared, HF or LC sensor also belongs to it as a stagnation flush which actuates every 24 hours a short flush. The latter is important, when sanitary rooms are not used for longer periods of time (e.g. during the school holidays) This ultimately ensures the drinking water quality is retained in the pipe systems.

Moreover, SCHELL only uses high-quality materials for its products, which can be easily cleaned; the timeless design with its rounded silhouettes contributes to a high standard of hygiene too. All in all, a clean affair.



WELL brochure

WELL takes hygiene criteria into account too.

The new pan-European label not only assesses efficient water and energy use for sanitary fittings. Hygiene aspects such as contact-free actuation or stagnation flush features are also accommodated in the classification process.

Detailed information about WELL, can be found in our WELL brochure (downloadable at www.schell.eu) or on the Internet at www.well-online.de

SCHELL inside.

WC flush systems
Concealed

WC flush systems
Wall mounted

Urinal flush systems
Concealed

Urinal flush systems
Wall mounted

Mounting modules

It's a tough game played in sanitary rooms.
But that's no reason for us to go on the defensive.

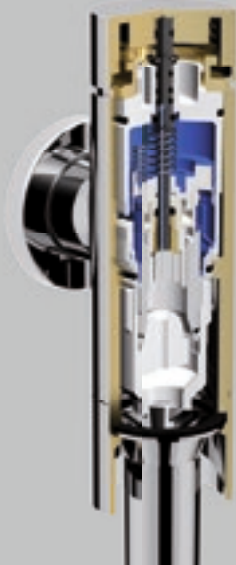

SCHELL combines intelligent technology and top quality materials



GL Systems Certification

High user frequency, carelessness, vandalism or contact with various cleaning agents – only several examples that highlight the fact that urinal and WC flush valves are subjected to an ordeal on a daily basis.

Reason enough for SCHELL to attach importance to using top-quality materials and having a sophisticated design. This is the only way to achieve a long service life and provide effective protection against any possible vandalism. SCHELL provides numerous solutions for this purpose. Hence there are SCHELL fittings made of all metal. As well as designs in plastic, we also offer

WC and urinal control and front-facing panels in single-pane safety glass and in stainless steel. Our HF and LC urinal control systems, for which the fittings do not have to be visibly installed behind ceramic units or tiles, have proven to be particularly vandal-proof.

But that's not enough: Our products and processes are continuously tested and are distinguished by the relevant quality and safety features: An example of this is quality management at SCHELL, which is certified by Germanischer Lloyd according to DIN EN IS 9001:2008. The best prerequisites for durable products »Made in Germany«.

SCHELL products brave a multitude of issues.
 With the exception of good taste!



AMBITION urinal design control panel



SCHELLOMAT BASIC urinal flush valve

Products by SCHELL have always epitomised stylish and functional design. They meet the most exacting requirements for aesthetics and can be easily integrated in modern sanitary rooms thanks to their timeless shape.

An additional benefit: The more sophisticated the site and attractive the design of the fitting – the higher the threshold for vandalism. All the more reason to opt for the multi-award winning SCHELL products.



DESIGN PLUS



reddo: design award



DESIGNPREIS
 NEHMEN SIE SIE

SCHELL inside.

WC flush systems
 Concealed

WC flush systems
 Wall mounted

Urinal flush systems
 Concealed

Urinal flush systems
 Wall mounted

Mounting modules

WC Flush Systems.





Concealed solutions | P. 12
Wall-mounted solutions | P. 20

Concealed WC flush systems.

By SCHELL.

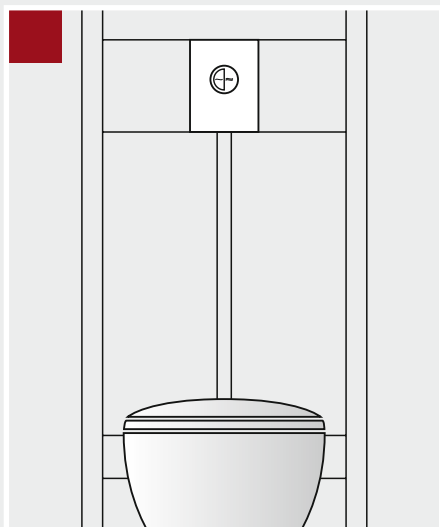

Solutions to suit your needs

An increasing number of concealed WC flush systems can be found in public, semi-public and commercial sanitary rooms. As the requirements can vary here, SCHELL has a broad range of products to provide the perfect solution. If, for example, always being ready to flush and minimal space requirement are important, then tried-and-tested SCHELL flush fittings fit the bill. If the pipe size is small, then a cistern by SCHELL is the right choice. Both systems feature water-saving functions as a matter of course.

Reliable flush valve systems

WC flush valves by SCHELL feature the self-closing SC cartridge. Characteristics: reliable operation thanks to corrosion-resistant top quality plastic. To prevent the build of deposits in the nozzle orifice, the WC cartridge additionally has an automatic nozzle cleaning pin. This is activated with every flush. A filter provides additional protection against contamination.

Modern cistern solutions and control panels

Cistern solutions by SCHELL have been specifically developed for public, semi-public and commercial sanitary rooms.

Vandal-proof quality

In contrast to privately used sanitary rooms, WC fittings in e.g. airports, railway stations or stadia have to withstand heavy duty usage. The SCHELL solution: Vandal-proof designs.

Stylish design

With SCHELL, you no longer have to compromise on sophisticated design in public, semi-public and commercial sanitary rooms.

Module for easy installation

Consistent to our concealed WC flush systems, you can obtain mounting modules by SCHELL, which make the installation phenomenally easy.

Your wish

The prefab kit solution
by SCHELL

Principle

Function

Technology

Special features

Roughing-in set

Control unit

Mounting module
Wet construction

Mounting module
Dry construction

More information

WC flush systems CONCEALED SOLUTIONS

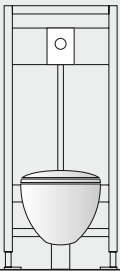
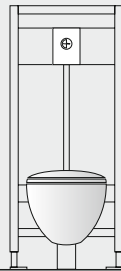
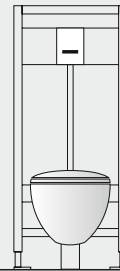
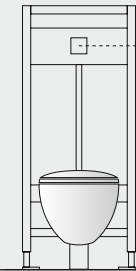
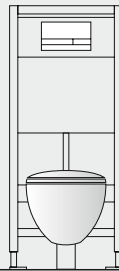
A water-saving and inexpensive solution, which is always ready to flush	A solution for low pressure	A flush valve solution for high standards of hygiene and economic water usage	A solution allowing the variably positioning of the flush actuation	An economical and water-saving solution for minimal pipe cross-section
AMBITION EDITION	EDITION ND EDITION ECO ND/ ND 100	EDITION E / EDITION E MANUAL	Ceiling-mounted flush valve EDITION E	LINEAR ECO AMBITION ECO
				
Manual actuation	Manual actuation	Actuated by exiting the sensor range	Manual actuation of the micro button	Manual actuation
<i>Hydraulic cartridge Push button</i>	<i>Hydraulic cartridge Push button</i>	<i>Infrared controlled flush valve</i>	<i>Electro-mechanically controlled hydraulic cartridge</i>	<i>Cistern system</i>
<ul style="list-style-type: none"> · Single/dual flush · 9 l flush · Adjustable 3 l economy flush · Attractive surfaces 	<ul style="list-style-type: none"> · Single/dual flush · Adjustable 6 l flush · 3 l economy flush · Attractive surfaces · Suitable for low pressure (0.8-2.5 bar) 	<ul style="list-style-type: none"> · Solenoid valve · Battery and mains operated design · Optional with mechanical actuation in the event of a power cut · Stagnation flush 	<ul style="list-style-type: none"> · Possibility to position the actuator to side · Flush volume variably adjustable · Disabled toilet installation possible 	<ul style="list-style-type: none"> · Available in various designs/variants · Disabled toilet installation possible · Adjustable 3 l economy flush
COMPACT II	COMPACT II ND	COMPACT II	COMPACT II	Mounting module
SC cartridge	SC cartridge	Solenoid valve + SC cartridge	Solenoid valve	Drain valve
No	No	No	No	Yes
Yes	No	Yes	Yes	Yes
Page 14	Page 15	Page 16	Page 17	Page 19

WC flush systems
Concealed

WC flush systems
Wall mounted

Urinal flush systems
Concealed

Urinal flush systems
Wall mounted

Mounting modules

EDITION and AMBITION WC flush systems

Two names, a multitude of variants.



COMPACT II WC flush valve



With the two WC flush valve series EDITION and AMBITION, SCHELL is providing a wide range of variants with differing designs for many areas of use. There is the self-closing EDITION version also for low pressure (EDITION ND). In addition, there is also an ECO version for both products offering dual-flush functionality. If a building structure only permits a wall installation depth of 100-160 mm, EDITION ECO 100 with dual-flush functionality is the perfect solution. A design variant of EDITION is AMBITION made of top quality single-pane safety glass, either in white or black. The heart of this WC flush valve is the COMPACT II roughing-in set for mounting the self-closing cartridge made of corrosion-resistant high-grade plastic (included in the prefab kit). The cartridge is protected from contamination thanks to a filter.

Advantages:

- Always ready to flush
- Cost-effective solution
- Durable cartridge technology with nozzle cleaning pin
- Attractive selection of compact control panels (153.5 x 124 mm)
- Adjustable flush volume (4.5 - 9 l)
- Suitable for 4.5 l WC economy ceramic units
- EDITION with numerous designs

Technical specifications:

- Flow pressure: 1.0 - 1.3 bar, from 0.8 bar for low-pressure designs
- Flush rate: 1 - 1.3 l/s
- Flush volume: 3/4.5 - 9 l, 3/4.5 - 6 l or low-pressure designs
- Noise class: I, II for low-pressure designs
- Valve connection: T 3/4 MT, T 1 MT for low-pressure designs
- Connection line: DN 25

Compatible with:

- COMPACT II dry construction mounting module

EDITION

EDITION/EDITION ECO for SCHELL COMPACT II concealed WC flush valve

- **Chrome**
Material: Front-facing panel made of plastic
- **Alpine white**
Material: Front-facing panel made of plastic
- **Vandal-proof**
Material: Stainless steel front-facing panel





COMPACT II WC mounting module



EDITION ECO WC operating panel

EDITION, low pressure (ND)

**EDITION ND/EDITION ECO ND/
EDITION ECO ND 100**
*for SCHELL COMPACT II ND
concealed WC flush valve*

- **Chrome**
Material: Front-facing panel
made of plastic
- **Alpine white**
(for the version with standard
installation depth only)
Material: Front-facing panel
made of plastic
- **Vandal-proof**
(for the version with standard
installation depth only)
Material: Stainless steel
front-facing panel

Minimal installation depth

**EDITION ECO 100/
EDITION ECO ND 100**
*for SCHELL COMPACT II/
COMPACT II ND concealed
WC flush valve*

- **Chrome**
Material: Front-facing panel
made of plastic

AMBITION

AMBITION
*for SCHELL COMPACT II
concealed WC flush valve*

- **White or black**
Material: Single-pane
safety glass



WC flush systems
Concealed

WC flush systems
Wall mounted

Urinal flush systems
Concealed

Urinal flush systems
Wall mounted

Mounting modules

EDITION E WC control system

Hygiene and water efficiency in perfect harmony.

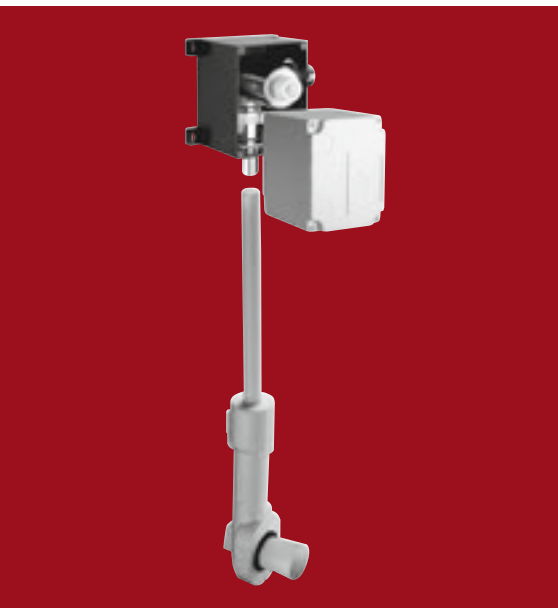

COMPACT II WC flush valve

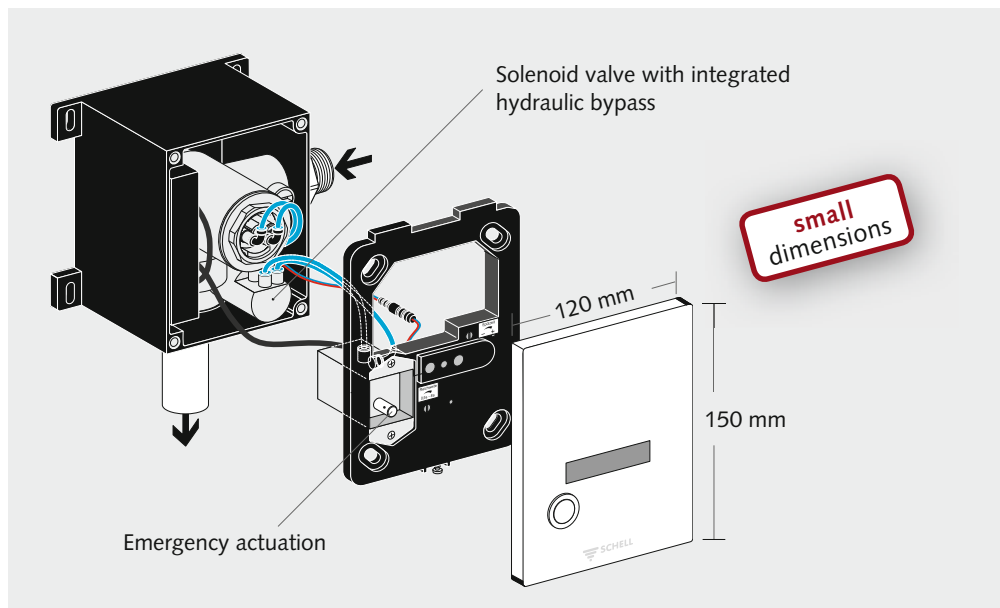

With the contact-free, infrared controlled EDITION E system for the COMPACT II concealed WC flush valve, SCHELL is offering a particularly hygienic and water-efficient solution that perfectly matches the EDITION urinal series. The flush is triggered by a hand approaching in the proximity area or automatically when leaving the WC (room monitoring). Good to know: The version with emergency actuation allows for the flush to be actuated manually via the push-button in the event of a power cut. The stainless steel front panel is designed for use in public and commercial sanitary rooms.

Advantages:

- Contact-free and thus a particularly hygienic solution
- Flush volume: 3.0-9.0 l
Factory setting: 6.0 l
- Durable cartridge technology with nozzle cleaning pin and cartridge solenoid valve

- Stagnation flush every 24 hours after the last flush
- Actuation via hand in front of sensor window 20-50 mm
- Room monitoring
Adjustable 500-800 mm
- Operation with battery or mains supply

Technical specifications:

- Flow pressure: 1.2-5.0 bar
- Flush rate: 1.0-1.3 l/s
- Flush volume: 3.0-9.0 l
- Noise class: I
- Valve connection: T 3/4 MT
- Connection line: DN 25
- Stagnation flush every 24 hours after the last flush

Compatible with:

- COMPACT II concealed WC flush valve
- COMPACT II dry construction mounting module

WC CONTROL SYSTEM

EDITION E

for SCHELL COMPACT II concealed WC flush valve

Material:

Stainless steel front-facing panel

- **Vandal-proof**



EDITION WC control with emergency actuation (delivery date on request)

WC ceiling-mounted flush valve EDITION E.

Switching to flexibility.

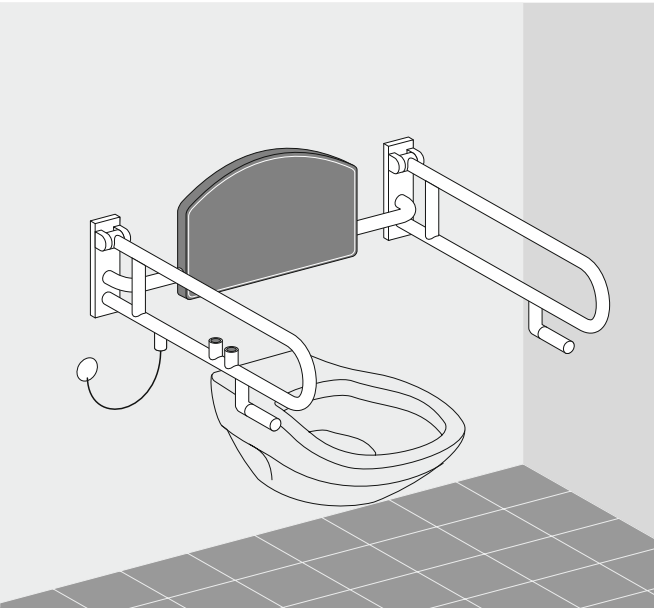

WC switch module

No two sanitary rooms are alike. Flexible solutions are required depending on the requirements and structural conditions in question.

This is where the WC flush valve comes to the fore. What makes it special: The valve is actuated electro-mechanically via the robust and attractive switch module. This can be attached irrespective of the position of the flush valve, allowing you to be flexible in terms of layout. For example, accessible on the wall next to the ceramic unit. For healthcare sector usage, the flush can be actuated via the buttons integrated in the grab rails. The installation of the flush valve in the wall can be just as flexible: It can be installed either conventionally behind the ceramic unit or in the ceiling. Even the installation in a supply tract is feasible.

Advantages:

- Always ready to flush
- Flush valve can be positioned to suit needs (ceiling or wall installation)
- Optional with water-saving dual flush feature available
- Vandal-proof all-metal switch module
- Sophisticated design

Technical specifications:

- Flow pressure: 1.2 - 5.0 bar
- Flush rate: 1.0 - 1.3 l/s
- Flush volume: 3.0 - 9.0 l
- Noise class: I
- Valve connection: T 3/4 MT
- Connection line: DN 25
- Stagnation flush every 24 hours after the last flush

Compatible with:

- COMPACT II concealed WC flush valve
- COMPACT II dry construction mounting module

SINGLE FLUSH

WC switch module
for SCHELL concealed
WC flush valve

- Chrome



DUAL FLUSH

WC switch module
for SCHELL concealed
WC flush valve

- Chrome



WC flush systems
Concealed

WC flush systems
Wall mounted

Urinal flush systems
Concealed

Urinal flush systems
Wall mounted

Mounting modules

WC cistern systems.

Function and Design in perfect harmony.



Proof that reliability and sophisticated design do not contradict one another can be found with the SCHELL cistern systems. We have the perfect solution for you – to suit whatever your wishes are for equipping private and particularly public, semi-public or commercial sanitary rooms. Be it dual flush, start/stop function or the convenient contact-free and thus hygienic actuation via infrared sensor. Apropos: If the infrared control should not work in the event of a power cut, it is only a matter of course that the flush can also be actuated manually (not for AMBITION E ECO). Be it attractive control panels made of plastic, glass or vandal-proof stainless steel. A wide choice of mounting modules for the most diverse of uses rounds off the range.

Advantages:

- Versions with water-saving dual-flush functionality, start/stop function or infrared control
- Sophisticated design
- Robust quality
- Individually adjustable flush volume (main flush: 6.0-7.5 l)
- Modules for free-standing or wall-mounting installation, suitable for dry and wet installations and disabled facilities

Technical specifications:

- Small flush volume: 3-4 l
- Large flush volume: 6.0/7.5 l, adjustable
- Default setting 6 and 3 l
- Valve connection: R 1/2 MT



MANUAL ACTUATION

LINEAR ECO

Dual flush

Material:

Front-facing panel made of plastic

Versions:

- Chrome
- Alpine white
- Brushed chrome

MANUAL ACTUATION

AMBITION ECO

Dual flush

Material:

Glass front-facing panel, Actuation buttons made of high-gloss chrome-plated brass

Versions:

- White
- Mint green
- Black

MANUAL ACTUATION

SCHELL WC operating panel

With start/stop function

Material:

Front-facing panel made of plastic

Versions:

- Chrome
- White



MANUAL ACTUATION

SCHELL WC operating panel

With start/stop function

Material:

Stainless steel front-facing panel

Design:

- Vandal-proof

INFRARED ACTUATION

SCHELL WC electronic fitting

for concealed cisterns

Manual actuation possible if there is a loss of power

Material:

Front-facing panel made of plastic

Design:

- Chrome

Wall-mounted WC flush valves.

By SCHELL.

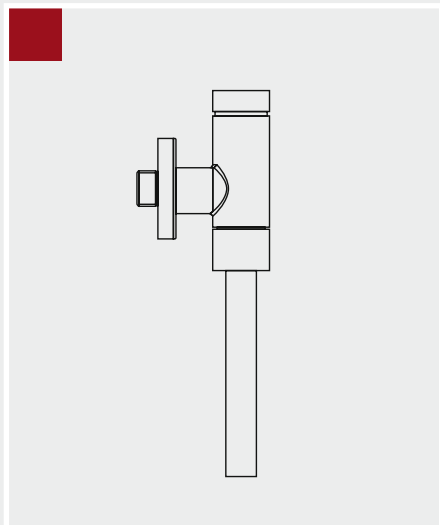

Perfect refurbishment solution

Whenever WC systems have to be refurbished and existing wall-mounted installations are to be used, flush valves made by SCHELL have proven to be ideal.

Always ready to flush

Advantage of every SCHELL wall-mounted WC flush valve: always ready to flush. This pays off in sanitary rooms with a high user frequency. For example in stadia, stations or schools.

Reliable cartridge technology

The self-closing SC cartridge is integrated in wall-mounted WC flush valves made by SCHELL. It is made of a corrosion-resistant polymer and ensure reliable operation. To prevent blockages arising in the nozzle orifice, the cartridge features an automatic nozzle cleaning pin which is active with every flush. A filter provides additional protection against contamination.

Robust materials

It's not for nothing that our fittings have an all-metal casing: They must put up with a considerable amount during every-day use.

Simple installation

A good refurbishment solution can only be successful if it is easy and quick to install. And that goes without saying for the wall-mounted WC flush valves by SCHELL.

WC FLUSH SYSTEMS: *Wall-mounted solutions*

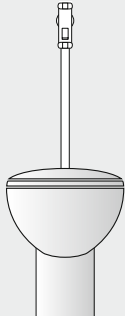
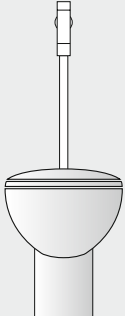
Your wish	A simple, cost-effective and fast refurbishment solution	An attractive solution for the inexpensive refurbishment
The solution by SCHELL:	SCHELLOMAT	SCHELLOMAT BASIC SCHELLOMAT BASIC ND (low pressure)
Principle		
Function	Manual actuation of the lever	Manual actuation of the push-button
Technology	<i>Hydraulic cartridge</i>	<i>Hydraulic cartridge</i>
Special features		· Noise class II (SCHELLOMAT BASIC, SCHELLOMAT BASIC ND low pressure)
Control unit	SC cartridge	SC cartridge
Mounting module	No	No
More information	Page 23	Page 23

WC flush systems
Wall mounted

Urinal flush systems
Concealed

Urinal flush systems
Wall mounted

Mounting modules

SCHELLOMAT wall-mounted WC flush valve.

One name, many solutions.



WCs with wall-mounted flush valves can still be found in many public, semi-public or commercial sanitary rooms. When the task in hand is make these rooms state-of-the-art, all roads lead to SCHELLOMAT.

Then, with this product line, we are offering a broad-ranging selection of solutions to suit your requirements. Beautiful in design, economic in water consumption terms, robust in every-day use and reliable in operation. And that for many years.

Advantages:

- Perfect for simple refurbishment projects
- Durable cartridge technology with nozzle cleaning pin
- Robust materials
- Optional integrated service isolating valve
- Available as ECO model with silent 3 l economy button
- Also available for low-pressure model



SCHELLOMAT

Technical specifications:

- For flush-out and wash-down bowls
- Flow pressure: from 1.2 bar
- Flush volume: 6 l
- For flush pipe Ø 28 x 26 mm
- Flush-flow regulation
- Automatic nozzle cleaning needle



SCHELLOMAT BASIC

Technical specifications:

- Flush rate: 1.0 - 1.3 l/s
- Flow pressure: 1.2 - 5 bar
- Flush volume: 4.5 - 9.0 l (adjustable)
- Noise class: II
- Integrated service isolating valve
- Valve connection: T 3/4 MT



SCHELLOMAT BASIC (low pressure)

Technical specifications:

- Flush rate: 1.0 - 1.4 l/s
- Flow pressure: 0.4 - 4 bar
- Flush volume: 8 - 14 l (adjustable)
- Noise class: II
- Valve connection: T 1 MT



SCHELLOMAT SILENT ECO

Technical specifications:

- Flush rate: 1.0 - 1.3 l/s
- Flow pressure: 1.2 - 5.0 bar
- Adjustable main flush volume: 4.5 - 9.0 l
- Economy button: 3.0 l
- Noise class: I
- Optional: integrated service isolating valve
- Valve connection: T 3/4 MT

WC flush systems
Wall mounted

Urinal flush systems
Concealed

Urinal flush systems
Wall mounted

Mounting modules

Urinal flush systems.



Concealed solutions | P. 26
Wall-mounted solutions | P. 34



Concealed urinal flush systems.

By SCHELL.

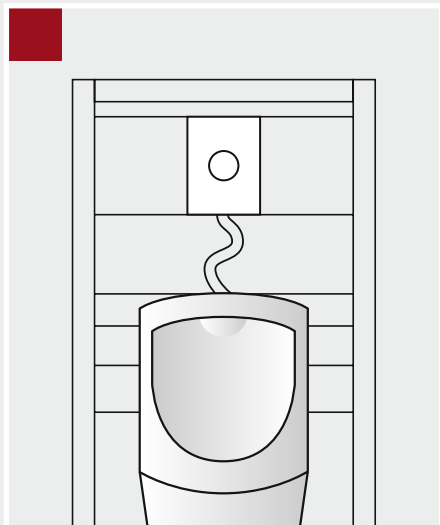

The SCHELL roughing-in set
COMPACT II



Solutions to suit your needs

Do you have high hygiene standards? Place value on economical water usage and robustness? Or planning a new build or refurbishment? Irrespective of which aspects in fitting public, semi-public sanitary rooms are being scrutinised – SCHELL offers an unparalleled broad-ranging series of concealed urinals to suit your requirements.

Intelligent technologies

Urinal fittings by SCHELL are available with manual actuation and electronic actuation via sensor. The integrated self-closing cartridge (supplied with the front-facing panels) used for manual actuation is made of corrosion-resistant plastic. Moreover, the cartridge is protected from contamination thanks to a filter. The flush volumes are easily and quickly adjusted via a setting screw at the front. Good to know: If your requirements should change, the mechanical cartridge can be replaced by an infrared-controlled variant.

Attractive front-facing panels

Nothing gets past these: Front-facing panels for urinal flush systems. SCHELL offers an attractive range of designs and materials such as chrome-plated plastic, stainless steel or single-pane safety glass. All have been specifically developed to suit the special requirements of public, semi-public and commercial sanitary rooms. Apropos: The front-facing panels for SCHELL WC and urinal flush systems have precisely the same compact dimensions.

Compatible modules

Be it wet or dry construction, be it a single installation or multiple installations – you can obtain the mounting modules compatible with SCHELL concealed urinal systems and which leave nothing to be desired.

Your wish

The solution by SCHELL:

Principle

Function

Technology

Special features

Control unit



COMPACT II
concealed WC flush valve

Mounting module
Wet construction

Mounting module
Dry construction

More information

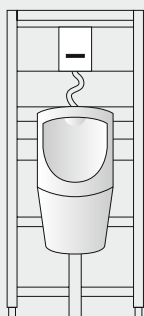
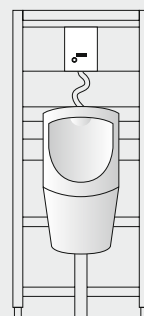
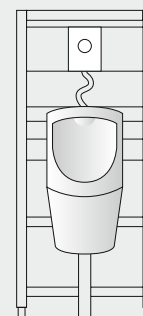
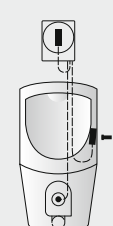
Urinal flush systems: CONCEALED SOLUTIONS

<p>A proven solution, contact-free with short reaction times.</p>	<p>A proven solution, contact-free with short reaction times. With manual operation for independent interval flushing</p>	<p>A reliable and inexpensive solution, which does not require an external energy source.</p>	<p>A universal solution for high standards of hygiene, economic water usage and protection against vandalism.</p>	<p>A hygienic and vandal-proof solution suitable for retrofitting.</p>
<p>AMBITION E EDITION E</p>	<p>EDITION E MANUAL</p>	<p>AMBITION EDITION</p>	<p>COMPACT LC</p>	<p>RETROFIT LC</p>
				
<p>Actuated by exiting the sensor range</p>	<p>Actuated by exiting the sensor range of flushing by manual operation</p>	<p>Manual operation</p>	<p>Actuated by movement and temperature change in the urinal siphon</p>	<p>Actuated by the detection of a urine stream within the bowl</p>
<p><i>Infrared sensor</i></p>	<p><i>Infrared sensor / Manual operation</i></p>	<p><i>Push-button</i></p>	<p><i>LC siphon sensor</i></p>	<p><i>HF ceramic sensor</i></p>
<ul style="list-style-type: none"> · Stagnation flush · Stadium operation 	<ul style="list-style-type: none"> · Stagnation flush · Stadium operation 	<ul style="list-style-type: none"> · No external power source required 	<ul style="list-style-type: none"> · Stagnation flush · Stadium operation · Overflow protection · Diagnosis via reed contact 	<ul style="list-style-type: none"> · Stagnation flush · Stadium operation · Overflow protection · For retrofitting · Diagnosis via reed contact
<p>Cartridge solenoid valve</p>	<p>Cartridge solenoid valve</p>	<p>SC cartridge</p>	<p>Cartridge solenoid valve</p>	<p>Cartridge solenoid valve</p>
<p>Yes</p>	<p>Yes</p>	<p>Yes</p>	<p>Yes</p>	<p>Yes</p>
<p>Yes</p>	<p>Yes</p>	<p>Yes</p>	<p>No</p>	<p>No</p>
<p>Yes</p>	<p>Yes</p>	<p>Yes</p>	<p>Yes</p>	<p>Yes</p>
<p>Page 28</p>	<p>Page 29</p>	<p>Page 30</p>	<p>Page 31</p>	<p>Page 33</p>

EDITION E/AMBITION E urinal control. Clean solutions.



Whoever has high standards in terms of hygiene, will find the EDITION E/AMBITION E urinal control the ideal solution. The infrared sensor detects the user and releases the preset flush-volume as soon as the sensor's detection range has been exited – and all of this is contact-free. The urinal control features an integrated stagnation flush to prevent standing water in the supply line and the build up of odour due to the siphon drying out. This ensures an automatic flush every 24 hours after the last actuation. Additional benefit: the water-saving setting for the flush duration. EDITION E/AMBITION E is available in 5 attractive front-facing panels of varying materials and either as a mains or battery-powered version. The battery-powered version contains a control diode in the sensor window to indicate any necessary battery change in good time.

Advantages:

- WELL classification (6 stars)
- Hygienic operation
- Reliable infrared control
- 5 attractive control panels (153.5 x 124 mm)
- Either mains or battery operated
- Integrated stagnation flush
- Stadium operation

Technical specifications:

- Flow pressure: 0.8 - 5 bar
- Flush rate: 0.3 l/s
- Flush volume: 1 - 6 l (adjustable)
- Noise class: I
- Valve connection: T 1/2 MT

Compatible with:

- COMPACT II concealed urinal flush valve
- COMPACT II dry construction mounting module
- COMPACT II wet construction mounting module

Front-facing panel designs:

EDITION E urinal control for SCHELL COMPACT II concealed urinal flush valve

- **Chrome/Alpine white**
Material: Front-facing panel made of plastic
- **Vandal-proof**
Material: Stainless steel front-facing panel

AMBITION E urinal control for SCHELL COMPACT II concealed urinal flush valve

- **White/Black**
Material: Single-pane safety glass



Front panel urinal control
EDITION E

EDITION E MANUAL urinal control. Clever all-round solution.



Highest hygiene in noble look – saves resources and designed for high user frequency. Those are the values that the urinal control EDITION E MANUAL scores with. Because, whether manually with electronic button or electronically controlled via infrared sensor – with the EDITION E MANUAL, the user always has the suitable solution for water-saving flushing procedures available.

Due to the combination of an optional battery or mains operated infrared control and the option for manual activation, independent intermediate flushing via the pushbutton can be carried out at all times. For example, during a cleaning procedure.

In addition, also good to know: The urinal controls are available with integrated stagnation flush. This acts with automatic flushing, 24 hours after the last activation, countering the standing water in the supply line and build-up of odours due to a dried syphon. And, of course, the flush time and stadium program can be individually set.

Advantages:

- Battery/mains operation with manual activation
- Contact-free infrared flushing system
- Automatic actuation when leaving the urinal (room monitoring)
- Manual actuation

Technical specifications:

- Flush time: Adjustable 1 - 15 s
- Room monitoring: Adjustable 300 - 700 mm
- Stagnation flush every 24 hours after the last flush
- Stadium program

Compatible with:

- COMPACT II concealed urinal flush valve
- COMPACT II dry construction mounting module
- COMPACT II wet construction mounting module

EDITION/AMBITION urinal control panel. Inexpensive. Robust. Beautiful.

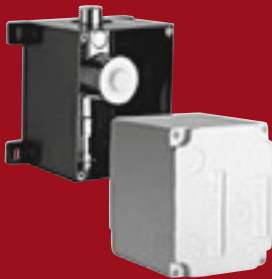

COMPACT II flush valve



Concealed flush valves by SCHELL are in vogue. This comes as no surprise as ultimately these offer reliable technology at low investment costs. Advantages that pay off when used in schools, gastronomy, administrative buildings or residential building projects. The timeless design of the control panels proves that looking good does not mean being impractical – and this is the case the vandal-proof stainless steel design and its single-pane toughened safety glass counterpart.

Apropos: If your requirements should ever change, the mechanical flush can be replaced by a infrared controlled, battery-operated flush.

Advantages:

- Self-closing
- Durable cartridge technology
- 4 attractive control panels
- Compact dimensions (153.5 x 124 mm)
- Large range of adjustment (1-6 litres)
- Prefilter for nozzle orifice

Technical specifications:

- Flow pressure: 0.8 - 5 bar
- Flush rate: 0.3 l/s
- Flush volume: 1.0 - 6.0 l
- Noise class: I
- Valve connection: T 1/2 MT

Compatible with:

- COMPACT II concealed urinal flush valve
- COMPACT II dry construction mounting module
- COMPACT II wet construction mounting module

Control panel designs

EDITION design control panel for SCHELL COMPACT II concealed urinal flush valve

- **Chrome/Alpine white**
Material: Front-facing panel made of plastic
- **Vandal-proof**
Material: Stainless steel front-facing panel

AMBITION design control panel for SCHELL COMPACT II concealed urinal flush valve

- **White/Black**
Material: Single-pane safety glass



Urinal control button
COMPACT EDITION

COMPACT LC urinal control. Clean, safe & universal usage.



COMPACT II flush valve



COMPACT LC placed behind urinal



COMPACT II HF/LC urinal
mounting module

Wherever the highest of hygiene standards and enormous robustness are required, the COMPACT LC is at its very best. This is because the sensor-controlled flush is actuated contact-free and is particularly hygienic. The concealed position of the flush valve, control electronics and power supply enables the COMPACT LC to defy the tough every day usage. The components can be located behind the ceramic unit or behind a robust stainless steel front cover above the urinal.

The encapsulated, corrosion-proof LC sensor is located in the siphon. It reliably detects the flush flow required by the user – even when there are major urine deposits or scaling. If the contents of the siphon should ever dry out or be extracted due to low pressure in the waste water system, the siphon is automatically topped up.

Reliable and simple, even the programming of the COMPACT LC: Three water-saving flush programmes can be set via an external reed switch with a magnetic key (1 l-flush, 2 l-flush, hybrid control for urinals with sealing liquid to prevent the build up of odour). There is also a service programme (with cleaning stop, cleaning flush and interval flush for intensive cleaning) available as well as a diagnostics programme (for checking the solenoid valve, sensor and battery capacity).

The COMPACT LC control can be used universally for all urinal bowls (including stainless steel bowls) together with the COMPACT II urinal roughing-in set.

COMPACT LC urinal control.

Clean, safe & universal usage.

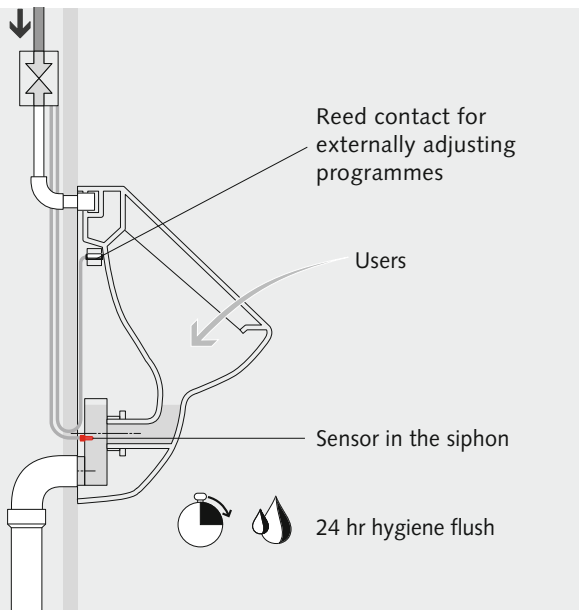

COMPACT LC placed above urinal

Advantages:

- Hygienic and vandal-proof control
- Universal usage for all ceramic and stainless steel bowls
- 3 water-saving flush programmes adjustable externally via a magnetic key
- Either mains or battery operated
- Integrated stagnation flush
- Stadium operation
- Integrated overflow protection
- Odour trap monitoring even at a low water level
- Hybrid programme

Technical specifications:

- Flow pressure: 0.8 - 5 bar
- Flush rate: 0.3 l/s
- Flush volume: 1 or 2 l
- Noise class: I
- Valve connection: T 1/2 MT

Compatible with:

- COMPACT II concealed urinal flush valve
- COMPACT II dry construction mounting module



- 1 Magnetic key for programme adjustment via reed contact
- 2 Siphon with integrated, encapsulated sensor

COMPACT RETROFIT LC urinal flush valve. The perfect refurbishment solution.



With its COMPACT RETROFIT LC, SCHELL is providing a solution that perfectly unites all the benefits of HF technology with the demands of refurbishment. It does not need to be expensive to upgrade old mechanical or electronic sanitary facilities with modern, hygienic and vandal-proof flush technology. This is because all installation features including special supply fixtures can be installed on the wall and then covered by the sanitary ceramic unit.

Porcelain urinal bowls with which LC solutions by SCHELL are compatible with include:

KERAMAG:

Aller, Public Line, Renova

VILLEROY & BOCH:

Magnum, Subway, Arriba

Wall-mounted urinal flush systems.

By SCHELL.

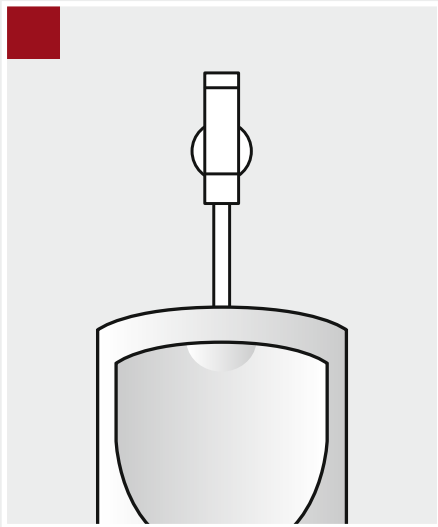

Perfect retrofitting options available

Wall-mounted urinal flush valves can always be found where the desire for a high degree of functionality must be combined with limited budgetary possibilities. Prerequisites that are typical of public, semi-public and commercial sanitary rooms. Hence it is all the more important that SCHELL has developed solutions that meet these contrasting requirements. Other features of these fittings include, water-saving technology, hygienic actuation, robust quality and attractive design.



Reliable cartridge technology

The self-closing SC cartridge is integrated in all wall-mounted urinal flush valves made by SCHELL. It is made of corrosion-resistant high-grade plastic/brass DIN EN and ensures reliable operation. To prevent deposits building up in the nozzle orifice, the cartridge features an automatic nozzle cleaning pin which is active with every flush. A filter provides additional protection against contamination.

Compatible modules

Using mounting modules allows for sanitary rooms to be set up or renovated more quickly – especially for series installation with a rail system. Hence, SCHELL can offer you ideal solutions for the efficient installation of our wall-mounted urinal flush valves.

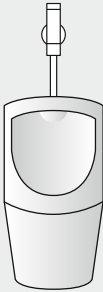
Urinal flush systems:
WALL-MOUNTED SOLUTIONS

Your wish	An inexpensive standard solution, which does not require an external energy source.	A contact-free solution that fulfils the highest of hygiene requirements.
The solution by SCHELL	SCHELLOMAT BASIC	SCHELLTRONIC
Principle		
Function	Manual actuation	Actuated by exiting the sensor range
Technology	<i>Push button</i>	<i>Infrared sensor</i>
Special features	<ul style="list-style-type: none"> · With or without isolating valve · No external power source required 	<ul style="list-style-type: none"> · For new builds and refurbishment projects · With isolating valve · 9 V alkaline battery · WELL classified (6 stars)
Control unit	SC cartridge	Cartridge solenoid valve
Mounting module	Yes	Yes
More information	Page 37	Page 39

SCHELLOMAT BASIC urinal flush valve.

Beautiful, robust and tailor-made for refurbishments.



Urinals with wall-mounted flush technology are always found where cost-effective and functional solutions are favoured. Such establishments include schools, service stations and gastronomy and commercial enterprises. If a new build or refurbishment of sanitary rooms is on the cards for one of these establishments, the SCHELLOMAT BASIC wall-mounted flush valve offers numerous benefits to developers and users alike. These are installed quickly and easily. The beautiful fitting made of brass features the latest cartridge technology by SCHELL and is exceptionally resistant to external influences. As the areas of use for wall-mounted fittings can vary, the SCHELLOMAT BASIC is available as a Benelux version with flush pipe \varnothing 15 x 300 mm. So much choice is a necessity.

Advantages:

- Perfect for simple refurbishment projects
- Durable cartridge technology
- Brass design
- Practical service shut-off valve
- Flush pipe \varnothing 18 x 200 mm
- Also available as Benelux version with flush pipe \varnothing 15 x 300 mm

Compatible with:

- Dry construction urinal mounting module



SCHELLOMAT BASIC

Technical specifications:

- Flush rate: max. 0.3 l/s
- Flow pressure: 0.8 - 5.0 bar
- Flush volume: 1 - 6 l (adjustable)
- Noise class: II
- Optional: integrated service isolating valve
- Valve connection: T 1/2 MT



SCHELLTRONIC infrared urinal flush valve.

More hygiene in an instance.



Satisfying high hygiene standards is easier than ever before with the SCHELLTRONIC wall-mounted solution. Then any dated manual fitting can be replaced by a infrared-controlled urinal flush valve without any additional modifications being necessary. The reliable infrared sensor system ensure that the flush can be actuated contact-free. Setting the flush volume required is conceivably easy. All components are easily accessible and are connected to each other with plugs that cannot be mis-connected. And if a battery needs replacing, the LED flashes prominently in the sensor window. A battery change just takes two minutes. And so that other urinals remain in use during service work, there is an isolating valve.

Appropriate to its usage in public, semi-public and commercial sanitary rooms, SCHELLTRONIC comprises a robust casing made of brass and features an integrated stagnation flush. This ensures an automatic flush 24 hours after the last actuation.

Advantages:

- WELL classification (6 stars)
- Contact-free operation
- Fulfills high hygienic requirements
- Easy to replace
- Robust materials
- Battery operation
- Isolating valve
- Attractive design
- Also available in Benelux version (incl. pipe interrupter)

Compatible with:

- Dry and wet construction urinal mounting module



SCHELLTRONIC

Technical specifications:

- Flush rate: 0.3 l/s
- Flow pressure: 0.5 - 5 bar
- Flush time: 2 - 15 s (adjustable)
- Noise class: II
- Valve connection: T 1/2 MT
- Flush pipe \varnothing 18 x 200 mm
- Optionally available with external connector for flush-pipe



SCHELLTRONIC Benelux model

Technical specifications:

- Flush rate: 0.3 l/s
- Flow pressure: 0.5 - 5 bar
- Flush time: 2 - 15 s (adjustable)
- Noise class: II
- Valve connection: T 1/2 MT
- Flush pipe \varnothing 15 x 300 mm
- Optionally available with external connector for flush-pipe



SCHELL – a clever decision. For mounting modules too.

SCHELL is your one-stop shop. This includes mounting modules too. These are ideal for professional and speedy installation. And this is made particularly clear with many sophisticated detailed solutions that make the installation easier for you.

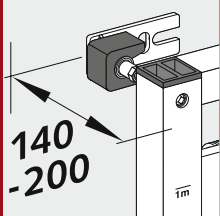

SCHELL

Wall mounting set

- Suitable for all SCHELL mounting modules
- Simple depth adjustment from the front using an internal hexagon socket
- Structure-borne noise insulated HDPE bearing

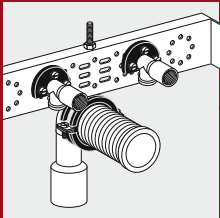

Noise insulation

The mounting feet and wall-bracket set are insulated against structure-borne noise as standard. Additional noise insulation measures are located in the ceramic unit fixings and the water inlets and drains.

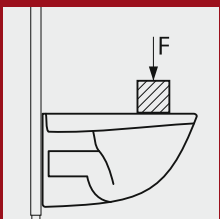

WC load test 400 kg
In conformity with
DIN EN 997

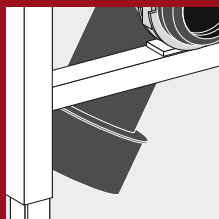

WC connection adapter
Ø 90/110 mm

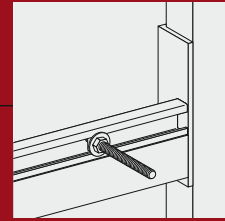

Dimensionally accurate adjustments

Quick and easy adjustment by shifting connections horizontally or vertically.

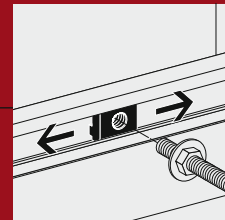

Threaded T-nuts

- Structure-borne noise insulation
- Easy adjustment and fixing
- Slip-resistant

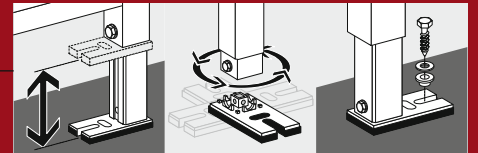

Mounting feet

Mounting feet for floor structures are height adjustable up to max. 200 mm. The foot plate can be turned by 4 x 90° to suit the type of installation. Fastening materials are included in the scope of delivery.

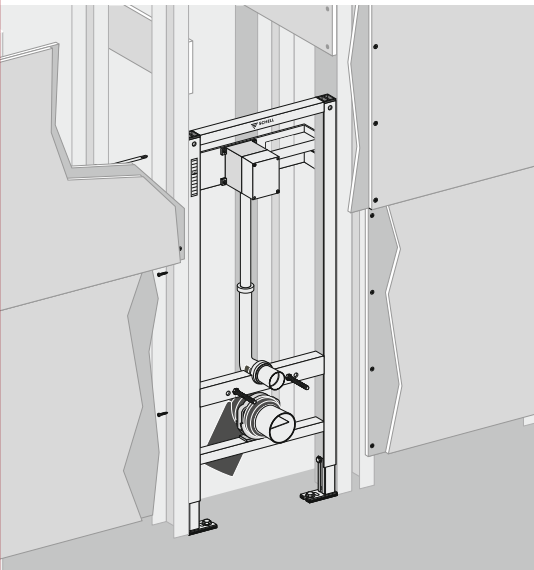

Mounted within a rail system
Dry construction

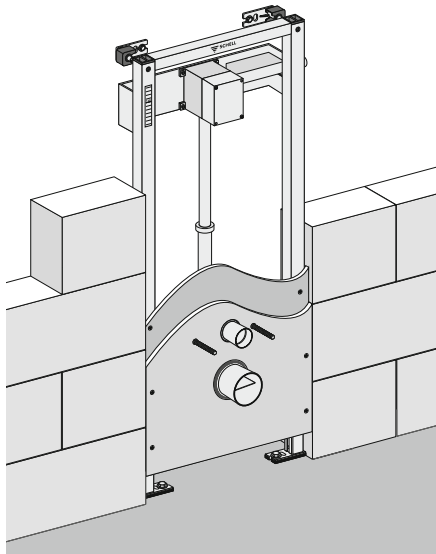

Mounted in front of a solid wall
Wet construction

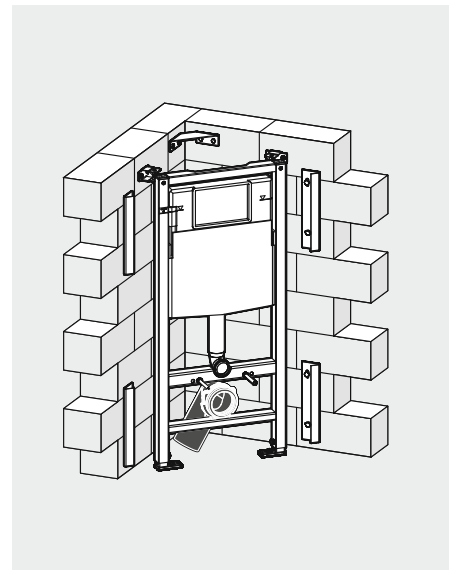

Angle mounting set

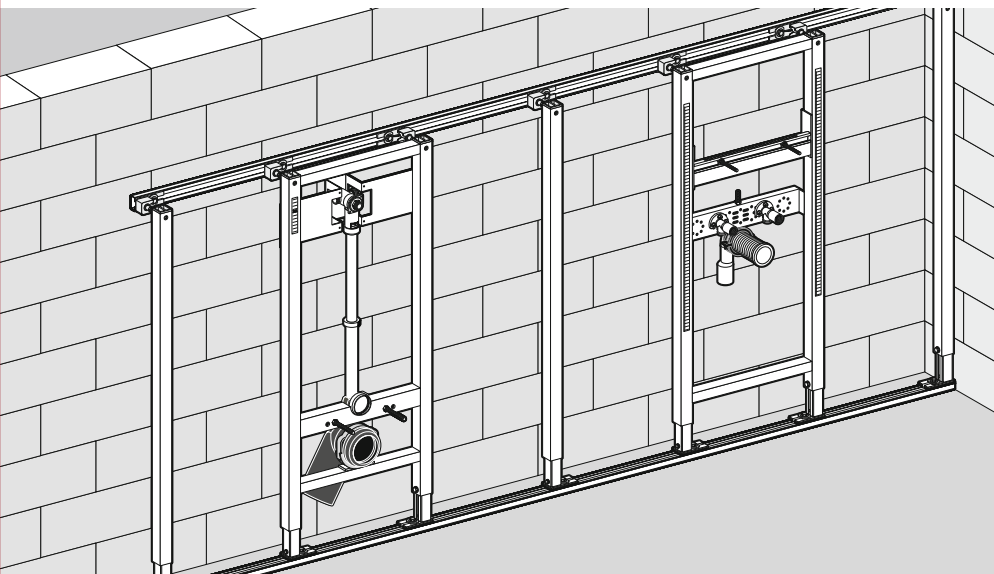

Mounting units within a rail system



The perfect supplement:
The brochure **»For professional sanitary rooms. Wall-mounted systems. By SCHELL.«** – also available as a download.



1 2



3 4

SCHELL – everywhere, where architects, planners and plumbers rely on no-compromise quality.



5 6



7 8



Photo: DMG/Christoph Münch

Large-scale renowned companies across the world trust in SCHELL when refitting their sanitary facilities. This is where the shared demand for design and quality in the details becomes apparent. SCHELL fittings are also used efficiently for redeveloping properties. Here are a few examples.

- 1 Ritter Sport Museum, Waldenbuch, Germany
- 2 Castle arcades, Braunschweig, Germany
- 3 Leisure pool, Schorndorf, Germany
- 4 Köln-Düsseldorfer, Deutsche Rheinschiffahrt Aktiengesellschaft, Germany
- 5 Sheraton Carlton, Nürnberg, Germany
- 6 Slavia Stadium, Prague, Czech Republic
- 7 Burj Khalifa Complex, Dubai, United Arab Emirates
- 8 Volkswagen AG, Dresden, Germany

Additional references can be found at www.schell.eu

SHELL GmbH & Co. KG
Fittings Technology
Raiffeisenstrasse 31
57462 Olpe
Germany
Tel. +49 2761 892-0
Fax +49 2761 892-199
info@schell.eu
www.schell.eu

